

# **Optimal Design of Discrete Output Feedback Control Using Genetic Algorithm for a Multi Area Power System**

**Ahmed Bensenouci**

*Electrical Engineering Department, Qassim University, Buraydah, Saudi Arabia*

*bensenouci@ieee.org*

*Abstract.* In this paper, a design of an optimal output feedback control for decentralized Load Frequency Controllers (LFC) of a multi-area interconnected power system using Genetic Algorithm (GA), is presented. The original system is decomposed into subsystems (areas). A Local Output Feedback Controller (LOFC) is designed for each subsystem and its relative optimal gain matrix is derived using GA. The proposed approach is implemented on a three-area interconnected power system and could be extended to more areas in different configurations (radial, ring). The system performance is analysed by simulating different disturbances. Effectiveness is shown through a comparative study with the Conventional Integral Control (CIC) for different operating conditions and a wide-range variation in the system parameters with the presence of the turbine Generation Rate Constraints (GRC) nonlinearity.

*Keywords:* Load Frequency Control, Overlapping Decentralized Technique, Output Feedback Control, Genetic Algorithm.

## **1. Introduction**

For economical reasons and reliability, neighboring power systems are connected. The net power flow on the tie lines connecting a system to another one is frequently scheduled by a prior contract basis <sup>[1-3]</sup>. System disturbances caused by load fluctuation result in changes in tie-line power and system frequency which give rise to a Load Frequency Control (LFC) problem. The LFC's goal is to regulate the power output of an electric power generator within a prescribed area, in response to changes in system frequency, tie-line loading, or both.

Researches in Ref. [4-8] employed optimal control theory to solve the LFC problem. However, the realization of such controller is difficult because the feedback portion of the optimal controller requires the measurement of all system state variables that are in general not

accessible. Even if state estimation techniques, employed in the power system control centers, are used to estimate the inaccessible state variables, the data needs to be transferred, in large interconnected systems, over long distances. In addition, the system data required for determining the control signal in each subsystem is measured in discrete mode and then transferred over telemetry<sup>[2,9]</sup>. It is also recognized that the centralized LFC poses many difficulties in telemetering the system data for process to a centralized controller when the size and complexity of the interconnected power system increases<sup>[9]</sup>. Accordingly, it is more reliable to deal with a decentralized LFC than a centralized one. In LFC problem, often the control criterion is to minimize the Area Control Error (ACE) who is defined as a linear combination of the tie-line power and the area frequency deviations from their set points. In this, significant efforts on control strategies for optimal feedback controllers were made [3-8,10-12].

In this paper, Genetic Algorithm (GA) is applied as an optimizer technique for the output feedback controller defined by a constant feedback gain matrix. GA application represents a new tool that is characterized by some good features as compared to classical optimization techniques<sup>[13-18]</sup>. The application is made to a decentralized LFC through Siljak's technique<sup>[19-20]</sup>. In order to achieve of the LFC requirements, the application of the Conventional Integral Control (CIC) is also considered for comparison purposes with GA based controller. In short, this paper provides a simple modified approach for designing discrete Local Output Feedback for decentralized LFC of an interconnected power system. The procedure is started by decomposing the interconnected power system into areas. A local discrete output feedback, based on the sampling interval, is designed for each area where GA is used to determine the Local Output Feedback Controller (LOFC) gains matrix. GA uses binary numbers to perform its main steps namely, selection, crossover, and mutation. The passage from binary to real is required since the cost function (fitness) is evaluated with real floating numbers. The proposed design procedure is applied to three interconnected power system. Effectiveness is demonstrated using different operating conditions and a wide-range variation in system parameters. To reflect practical situations, the effect of the turbine GRC nonlinearity<sup>[21-23]</sup> is investigated. The results are presented to show the validity of the proposed controller for different operating conditions and a wide-range in parameters variation, in the presence of the turbine Generation Rate Constraints (GRC) nonlinearity.

## 2. Power System Modeling and Decomposition

The proposed control methodology is implemented on a three-area interconnected power system of which one is a hydro and the others are steam with/without reheat power plants <sup>[21-23]</sup>, respectively.

### 2.1 Continuous-Time Dynamic Model

The continuous linear dynamic model, in state-space form, can be written as:

$$\dot{\mathbf{x}} = \mathbf{A}\mathbf{x} + \mathbf{B}\mathbf{u} \quad (1)$$

Where

- $\mathbf{x}$  state vector (nx1, n=13)
- $\mathbf{u}$  control & disturbance vector (6x1)
- $\mathbf{u} = \left[ \Delta P_{d1} \Delta P_{c1} \Delta P_{d2} \Delta P_{c2} \Delta P_{d3} \Delta P_{c3} \right]^t$
- $\mathbf{A}$  (nxn) &  $\mathbf{B}$  (nx6) constant matrices

The state variables and inputs are defined as follows:

- Incremental frequency deviations:  
 $\Delta F_1 = x_1, \Delta F_2 = x_6, \Delta F_3 = x_{11}$
- Incremental change in tie-line powers:  
 $\Delta P_{tie1} = x_5, \Delta P_{tie2} = x_{10} - x_5, \Delta P_{tie3} = -x_{10}$ .
- Incremental load demand change:  $\Delta P_{di}$  (i=1-3): disturbance
- Incremental speed changer position:  $\Delta P_{ci}$  (i=1-3): control
- Area control error:  $ACE_i = \Delta P_{tie_i} + B_i \Delta F_i$ ,  $B_i$ : weight factor (i=1-3)

The entries of  $\mathbf{A}$  and  $\mathbf{B}$  can be deduced from Fig. 1 and the Appendix.

### 2.2 System Decomposition

The overlapping decentralization technique proposed by Siljak <sup>[19-20]</sup> is employed to decompose the full system into subsystems (areas). In this technique, the areas represent the subsystems while the change in tie-line power is the overlapping part. The details of decomposition of interconnected multi-areas of LFC in longitudinal connection have been proposed in Ref. [7]. In the considered case, the system is decomposed into three component ( $\tilde{\mathbf{x}}_1, \tilde{\mathbf{x}}_2$  &  $\tilde{\mathbf{x}}_3$ ) representing the 3 areas and defined by

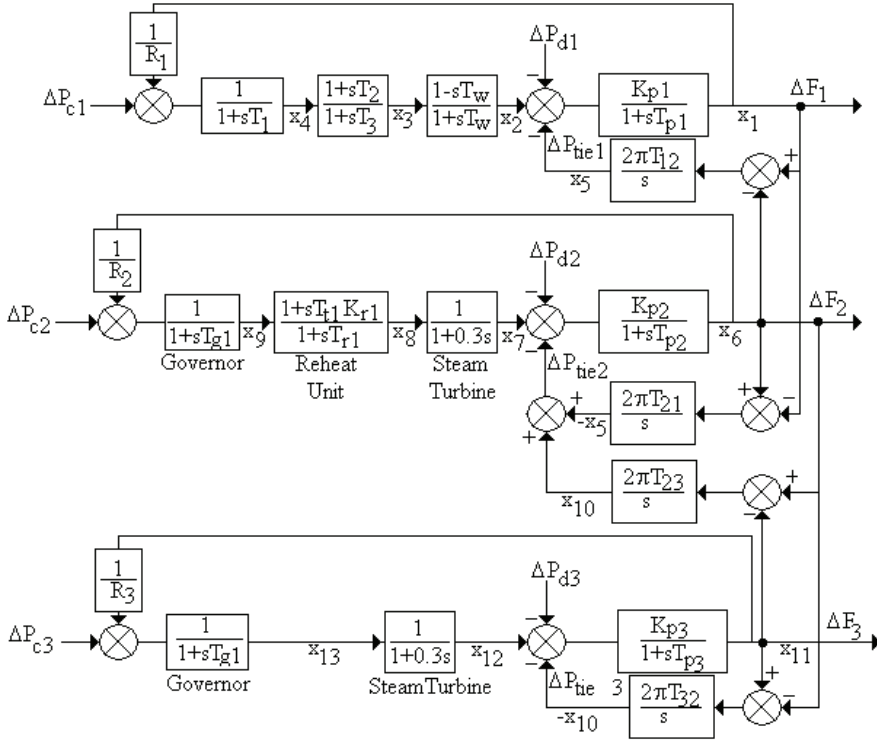


Fig. 1. A three-area interconnected power system.

$$\begin{cases} \tilde{\mathbf{x}}_1 = [x_1 \ x_2 \ x_3 \ x_4 \ x_5]^t \\ \tilde{\mathbf{x}}_2 = [x_5 \ x_6 \ x_7 \ x_8 \ x_9 \ x_{10}]^t \\ \tilde{\mathbf{x}}_3 = [x_{10} \ x_{11} \ x_{12} \ x_{13}]^t \end{cases} \quad (2)$$

With this representation, the system becomes

$$\begin{bmatrix} \tilde{\mathbf{x}}_1 \\ \tilde{\mathbf{x}}_2 \\ \tilde{\mathbf{x}}_3 \end{bmatrix} = \begin{bmatrix} \mathbf{A}_{11} & \mathbf{A}_{12} & \mathbf{A}_{13} \\ \mathbf{A}_{21} & \mathbf{A}_{22} & \mathbf{A}_{23} \\ \mathbf{A}_{31} & \mathbf{A}_{32} & \mathbf{A}_{33} \end{bmatrix} \begin{bmatrix} \tilde{\mathbf{x}}_1 \\ \tilde{\mathbf{x}}_2 \\ \tilde{\mathbf{x}}_3 \end{bmatrix} + \begin{bmatrix} \mathbf{B}_{11} & \mathbf{B}_{12} & \mathbf{B}_{13} \\ \mathbf{B}_{21} & \mathbf{B}_{22} & \mathbf{B}_{23} \\ \mathbf{B}_{31} & \mathbf{B}_{32} & \mathbf{B}_{33} \end{bmatrix} \begin{bmatrix} \mathbf{u}_1 \\ \mathbf{u}_2 \\ \mathbf{u}_3 \end{bmatrix} \quad (3)$$

Where  $\mathbf{A}_{ij}$ ,  $\mathbf{B}_{ij}$  ( $i, j=1-3$ ) are subsystem matrices whose elements depend on the system parameters and

$$\mathbf{u}_i = [\Delta P_{di}, \Delta P_{ci}]^t \quad (i=1-3)$$

The new state vector  $\tilde{\mathbf{x}}$  ( $n \times m$ ), with  $n=15$  and  $m=1$ , is related to  $\mathbf{x}$  by:

$$\tilde{\mathbf{x}} = \mathbf{T}\mathbf{x} \quad (4)$$

Where  $\mathbf{T}$  is a non-square matrix ( $15 \times 13$ ) defined by:

$$\mathbf{T} = \begin{bmatrix} \mathbf{I}_4 & 0 & 0 & 0 & 0 \\ 0 & 1 & 0 & 0 & 0 \\ 0 & 1 & 0 & 0 & 0 \\ 0 & 0 & \mathbf{I}_4 & 0 & 0 \\ 0 & 0 & 0 & 1 & 0 \\ 0 & 0 & 0 & 1 & 0 \\ 0 & 0 & 0 & 0 & \mathbf{I}_3 \end{bmatrix} \quad (5)$$

Where  $\mathbf{I}_i$  is an identity matrix of dimension "i" whereas 0 is a matrix of 0 entries and proper dimension, "1" number one.

The expanded system can be reformulated using overlapping subsystems as follows:

$$\tilde{\mathbf{x}} = \tilde{\mathbf{A}}\tilde{\mathbf{x}} + \tilde{\mathbf{B}}\mathbf{u} \quad (6)$$

Where  $\tilde{\mathbf{A}}$  ( $15 \times 15$ ) and  $\tilde{\mathbf{B}}$  ( $15 \times 6$ ) represent the overlapping expanded system matrices and

$$\tilde{\mathbf{A}} = \mathbf{T}\mathbf{A}\mathbf{T}^* + \mathbf{M} \quad (7)$$

$$\tilde{\mathbf{B}} = \mathbf{T}\mathbf{B} \quad (8)$$

$$\mathbf{T}^* = (\mathbf{T}^t \mathbf{T})^{-1} \mathbf{T}^t \quad (9)$$

$\mathbf{M}$  is a square matrix ( $15 \times 15$ ) whose elements are all zeroes only:

$$M_{15} = \frac{K_{p1}}{2t_{p1}}, \quad M_{16} = -M_{15}, \quad M_{75} = \frac{K_{p2}}{2t_{p2}}, \quad M_{76} = -M_{75} \quad (10)$$

$$M_{11,5} = \frac{K_{p2}}{2t_{p2}}, \quad M_{11,6} = -M_{11,5}, \quad M_{13,11} = \frac{K_{p3}}{2t_{p3}}, \quad M_{13,12} = -M_{13,11}$$

Using the previous equations, the expanded system can be described as:

$$\tilde{\mathbf{x}}_i = \tilde{\mathbf{A}}_i \tilde{\mathbf{x}}_i + \tilde{\mathbf{B}}_i \mathbf{u}_i + \sum_{i \neq j} \tilde{\mathbf{A}}_{ij} \tilde{\mathbf{x}}_j + \sum_{i \neq j} \tilde{\mathbf{B}}_{ij} \mathbf{u}_j \quad (11)$$

Where  $\tilde{\mathbf{A}}_i$  and  $\tilde{\mathbf{B}}_i$  ( $i=1-3$ ) are the matrices corresponding to the three decoupled subsystems. The control input to each subsystem is defined by  $\mathbf{u}_i = [\Delta P_{di}, \Delta P_{ci}]^t$ .

For the control purpose, assume weak coupling element such as  $\tilde{\mathbf{A}}_{ij}$  &  $\tilde{\mathbf{B}}_{ij}$  ( $i \neq j$ ) can be neglected. Therefore, the decoupled controlled subsystems are given by:

$$\tilde{\mathbf{x}}_i = \tilde{\mathbf{A}}_i \tilde{\mathbf{x}}_i + \tilde{\mathbf{B}}_i \mathbf{u}_i \quad (12)$$

It must be noted that the system described by (1) and the subsystems, obtained after decoupling process using (12), should be controllable.

### 2.3 Discrete-Time Dynamic Model

A discrete-time model for each subsystem can be obtained, for  $i=1-3$ , from (12) in the form:

$$\begin{cases} \mathbf{x}_i(k+1) = \Phi_i \mathbf{x}_i(k) + \Delta_i \mathbf{u}_i(k) \\ \mathbf{y}_i(k+1) = \mathbf{C}_i \mathbf{x}_i(k+1) \end{cases} \quad (13)$$

where,  $\mathbf{x}_i(k) = \mathbf{x}_i(kT_s)$ ,  $\mathbf{u}_i(k) = \mathbf{u}_i(kT_s)$  are specified at  $kT_s$ ,  $k=0,1,\dots$  and  $\Phi_i$ ,  $\Delta_i$  are the state transition and input driving matrices for  $i=1, 2$  and  $3$ , respectively, which depend on the sampling interval  $T_s$ . To simplify the analysis, “ $i$ ” is dropped. Equation (13) can be rewritten as:

$$\begin{cases} \mathbf{x}_{k+1} = \Phi \mathbf{x}_k + \Delta \mathbf{u}_k \\ \mathbf{y}_k = \mathbf{C} \mathbf{x}_k \end{cases} \quad (14)$$

## 3. Output Feedback Control

On the basis of an assumed sampling interval  $T_s$ , the state prediction equation of the discrete-time linear model described by (14) can be derived as shown in Appendix 3.

The prediction equation of the augmented vector  $\mathbf{w}_{k+1}$  is:

$$\mathbf{w}_{k+1} = \Theta \mathbf{w}_k + \Omega \mathbf{u}_k \quad (15)$$

The output control law,  $\mathbf{u}_o = \mathbf{F}_o \mathbf{w}_k$ , may be found by minimizing, with respect to  $\mathbf{u}_o$ , the quadratic-performance index:

$$J_o = \sum_{k=0}^r \left[ \mathbf{w}_k^t \mathbf{Q} \mathbf{w}_k + \mathbf{u}_k^t \mathbf{R} \mathbf{w}_k + \mathbf{u}_k^t \mathbf{S} \mathbf{u}_k \right] \quad (16)$$

Where

$$\begin{cases} \mathbf{Q} = \mathbf{F}_5^t \mathbf{Q}_s \mathbf{F}_5 \\ \mathbf{R} = 2\mathbf{F}_4^t \mathbf{Q}_s \mathbf{F}_5 \\ \mathbf{S} = \mathbf{F}_4^t \mathbf{Q}_s \mathbf{F}_4 + \mathbf{H}_s \end{cases} \quad (17)$$

The matrix  $\mathbf{F}_o$  is the optimal output feedback gains matrix. To obtain  $\mathbf{Q}$ ,  $\mathbf{R}$  and  $\mathbf{S}$  matrices,  $\mathbf{F}_4$  and  $\mathbf{F}_5$  must be known. The matrices  $\mathbf{Q}_s$  and  $\mathbf{H}_s$  are weighting matrices that should be selected properly to meet some desired performance. The former should be symmetric positive semi-definite whereas, the later should be symmetric positive definite matrix to get the global minimum<sup>[24-25]</sup>.

To calculate the output feedback control gains  $\mathbf{F}_o$ , two optimization solver techniques are presented, namely, Genetic Algorithm (GA) and the Dynamic Programming (DP).

#### 4. Dynamic Programming (DP)

Dynamic Programming (DP) technique is used to minimize a cost function  $J_o$  given by (16) at several stages starting from initial stage  $k=0$  and moving backward until stage  $k=r$ . If  $r$  is large enough, the DP algorithm converges to  $\mathbf{F}_o$  that is constant. The multi-stage dynamic programming algorithm<sup>[24-25]</sup> is summarized as follows:

Step1: Initialization process

$$\sigma = \mathbf{0}$$

Compute

$$\eta = \mathbf{R} + 2 * \Omega^t * \sigma * \theta$$

$$\mu = \mathbf{S} + \Omega^t \sigma \Omega$$

$$\mathbf{F} = -\mathbf{0.5} * \mu^{-1} \eta$$

$$k=1$$

Step 2: Iterate while  $k > 0$

$$\{\mathbf{F}_o = \mathbf{F}$$

$$\begin{aligned}
\sigma &= \mathbf{Q} + \theta^t \sigma \theta + \mathbf{F}^t \eta + \mathbf{F}^t \mu \mathbf{F} \\
\mu &= \mathbf{S} + \Omega^t \sigma \Omega \\
\eta &= \mathbf{R} + 2 * \Omega^t * \sigma * \theta \\
\mathbf{F} &= -0.5 * \mu^{-1} \eta \\
\text{If } |\mathbf{F} - \mathbf{F}_0| &> \text{tolerance, break, stop} \\
k &= k+1; \\
\} \\
\mathbf{F}_D &= \mathbf{F}
\end{aligned}$$

Where  $\mathbf{F}_D$  is the Dynamic programming gains matrix.

## 5. Optimization Problem Formulation

To obtain a constant output feedback control gains matrix  $\mathbf{F}_0$  using an optimization technique, replace  $\mathbf{u}_k$  by  $\mathbf{u}_k = \mathbf{F}_0 \mathbf{w}_k$  into (16) to get;

$$J_o = \sum_{k=0}^r \left[ \mathbf{w}_k^t (\mathbf{Q} + \mathbf{F}_0^t \mathbf{R} + \mathbf{F}_0^t \mathbf{S} \mathbf{F}_0) \mathbf{w}_k \right] \quad (18)$$

On the basis of assumed sampling time interval  $T_s$ , the optimization problem is thus defined by:

$$\text{Find } \mathbf{F}_0 \text{ that minimizes } J_o = \sum_{k=0}^r \left[ \mathbf{w}_k^t \mathbf{G} \mathbf{w}_k \right]$$

With respect to  $\mathbf{u}_k = \mathbf{F}_0 \mathbf{w}_k$

Using Genetic Algorithm (GA)

With  $\mathbf{G}$  matrix is given by  $\mathbf{G} = \mathbf{Q} + \mathbf{F}_0^t \mathbf{R} + \mathbf{F}_0^t \mathbf{S} \mathbf{F}_0$ .

## 6. Genetic Algorithm (GA)

GA is based on the selection of a cost function and a search interval then an initial population, randomly chosen inside the search interval, and finally, an iterative application of the three main steps; *reproduction*, *crossover*, and *mutation*, until convergence (stabilization of the fitness function) is obtained or a specific number of iterations is reached. The 3 steps are described as follows <sup>[16-17]</sup>:

### *Reproduction*

Select the chromosomes from current generation (population) to be parents to the next generation. A chromosome is selected (reproduced) based on its fitness. Chromosomes with lowest fitness values are



discarded and those with higher fitness values, *i.e.*, fittest, are kept for the next generation, *i.e.*, they survive.

### **Crossover**

To produce a variety in the next generation, some members (chromosomes) are paired randomly. Each paired string exchanges a randomly chosen portion of its bits with its mate. This produces new chromosomes that maintain many of the characteristics of their parents.

### **Mutation**

After crossover, each chromosome of the population will alter some of its bits, *i.e.* if bit is 0 it is changed to 1 and vice-versa. Usually, the number of bits altered is very low. The mutation step prevents the algorithm from losing some potentially useful information that might prevent the algorithm from reaching its optimum.

The detailed algorithm of GA is described in Appendix B. Other varieties of GA exist and can be found in the literature.

## **7. Simulation Results**

The digital simulation is done using MATLAB Platform with the following data for GA:

$P_c$	= 0.25	Crossover probability
$P_M$	= 0.1	Mutation probability
$N_{pop}$	= 10	Population number
$N_b$	= 10	binary string length

The system used comprises 3 areas; one hydro and 2 steam power plants one with and the other without reheat, as shown in Fig. 1. Under normal operating conditions, the simulation is started by calculating the OFC gains for each area using GA, as shown in Table 1.

**Table 1. OFC gains matrices.**

$F_o$		
0.0491	0.0267	0.0012
-0.0044	-0.0320	-0.0014
0.0430	-0.0217	-0.0217
-0.0219	-0.0504	0.0399
-0.0113	-0.0187	-0.0218
-0.0494	0.0274	-0.0288
0.0351	0.0269	-0.0384
0.0185	0.0309	-0.0396
-0.0197	0.0324	0.0405

To be more practical, the turbine Generation Rate Constraints (GRC) nonlinearity should be included in the system. The GRC for these plants may be represented by adding a limiter to the turbine model. The generation rate limiter of 10% MW per minute<sup>[21-23]</sup> is considered, *i.e.*,

$$d(\Delta P_{gi})/dt \leq \delta$$

where

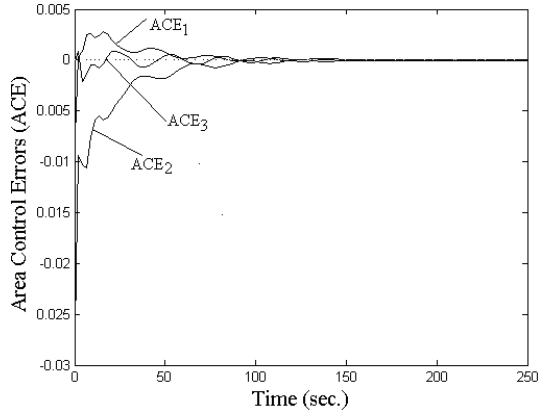
$$\delta = 10\% \text{ MW/min} = 0.17\% \text{ MW/s}$$

The governor dead-band (DB) is simulated using the describing function approach.

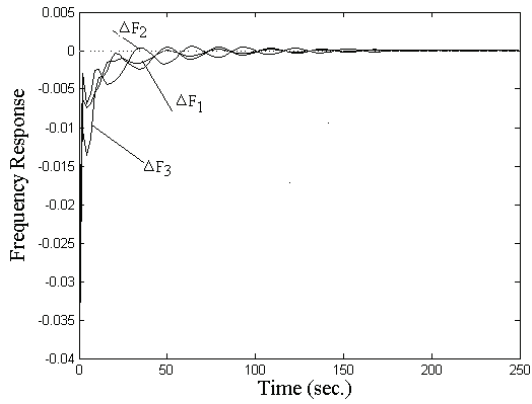
In the following tests, the nonlinearity is considered only in the last one.

Figure 2 shows the transient responses of ACE,  $\Delta F$  and  $\Delta P_{tie}$  of the three areas with 1% step change in  $\Delta P_{di}$  ( $i=1-3$ ). Similarly, Fig. 3 shows the transient responses of  $ACE_1$ ,  $\Delta F_1$  and  $\Delta P_{tie1}$  when the system is subjected to a step input of  $\Delta P_{d1}=\Delta P_{d2}=5\%$  and  $\Delta P_{d3}=3\%$  using both GA and CIC. The responses of the controlled system using either CIC or GA verify the LFC requirements of removal of steady state errors but GA shows better performance than CIC. For further testing the effectiveness of the proposed controllers, the system parameter values ( $Tp_1, kp_1, Tp_2, kp_2, R_1$ ) are increased by 20% and ( $Tp_3, kp_3, R_2, R_3$ ) by 30 % simultaneously, from their base case values. Figure 4 shows the transient response of ACE,  $\Delta F$  and  $\Delta P_{tie}$  when the three areas are subjected to 5%, 5% and 3% step change in  $\Delta P_{di}$  ( $i=1-3$ ), respectively, besides the parameter changes mentioned previously. For a wide-range testing of For further testing the effectiveness of the proposed controller, the system parameter values ( $Tp_i, kp_i, R_i$ ) where  $i=1-3$ , are increased by 50% from nominal values with the presence of the GRC nonlinearity. Figure 5 shows the transient response of ACE,  $\Delta F$  and  $\Delta P_{tie}$  when the three areas are subjected to 5%, 5% and 3% step change in  $\Delta P_{di}$  ( $i=1-3$ ), respectively, while experiencing a wide-range parameters variation and the presence of the GRC nonlinearity. The results indicate that the proposed controller yield good performance whereas the CIC fails as shown in Fig. 6.

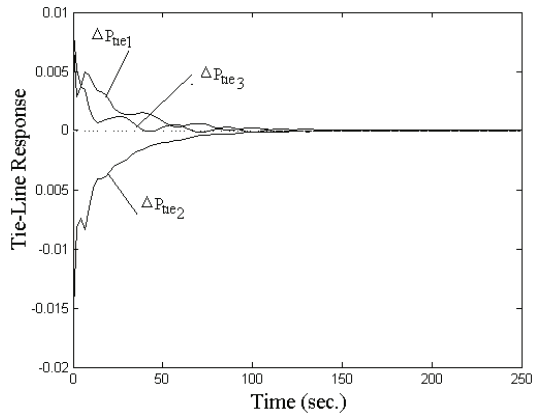
This research work was limited to the comparison of the results obtained using GA to those of CIC however, the obtained results were also compared to those done using optimization techniques namely, Simulated Annealing (SA) and Evolutionary Programming (EP), as applied to Load Frequency Control (LFC)<sup>[26-27]</sup>. The results were found excellent and very close.



**Fig. 2(a). Area Control Error Response.**

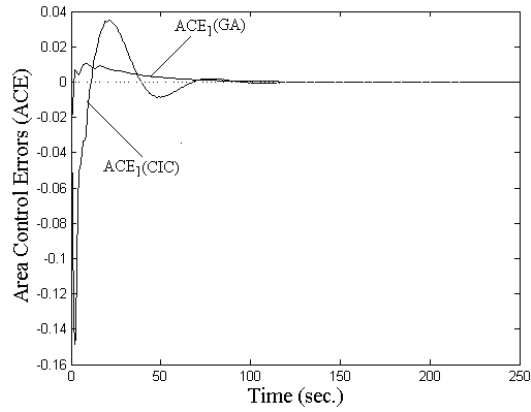


**Fig. 2(b). Frequency Response.**

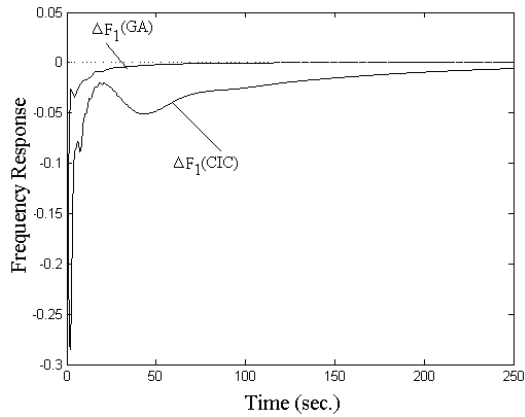


**Fig. 2(c). Tie-Line Power Response.**

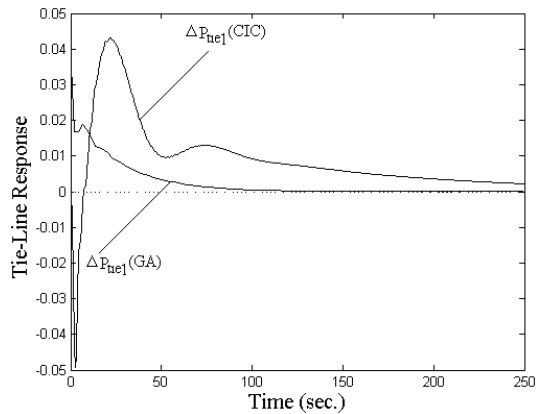
**Fig. 2. System Response due to  $\Delta P_{di}=1\%$ ,  $i=1-3$ , (GA).**



**Fig. 3(a). Area Control Error Response (Area 1).**

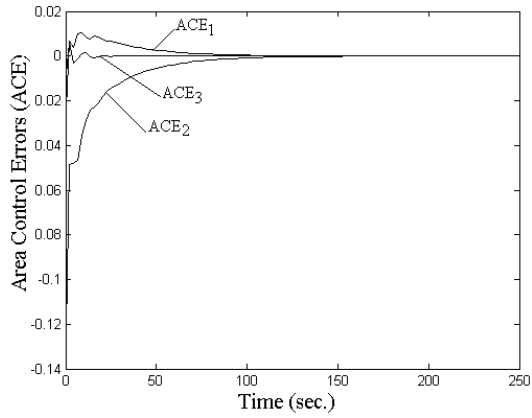


**Fig. 3(b). Frequency Response (Area 1).**

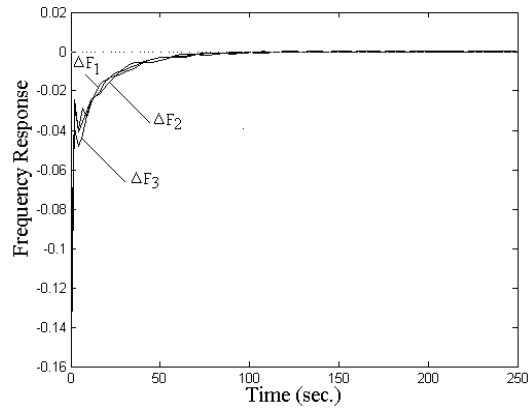


**Fig. 3(c). Tie-Line Power Response (Area 1).**

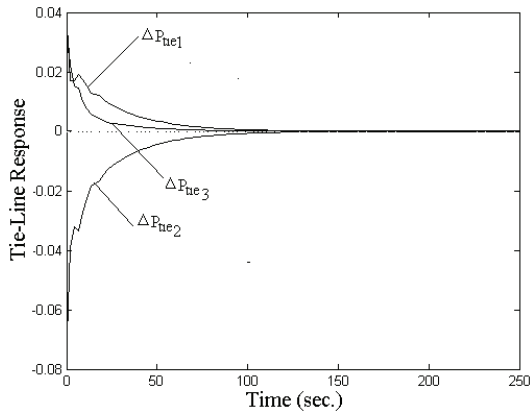
**Fig. 3. System Response for CIC & GA ( $\Delta P_{d1}=\Delta P_{d2}=5\%$  &  $\Delta P_{d3}=3\%$ ).**



**Fig. 4(a). ACE Response.**

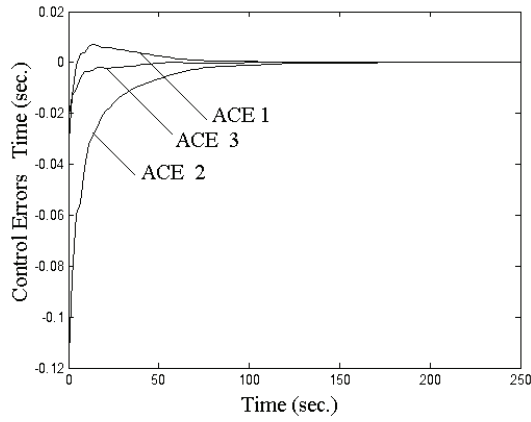


**Fig. 4(b). Frequency Response.**

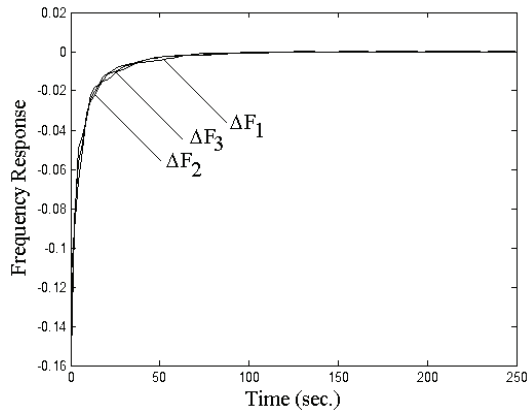


**Fig. 4(c). Tie-Line Power Response.**

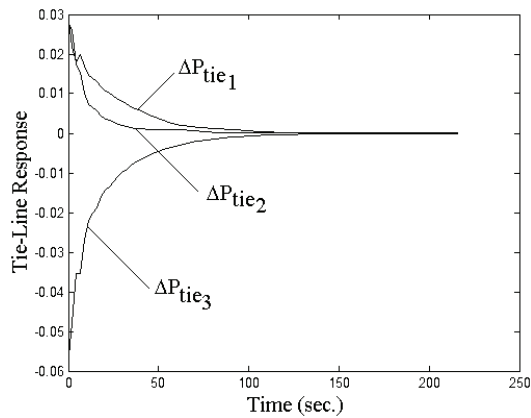
**Fig. 4. System Response due to  $\Delta P_{d1}=\Delta P_{d2}=5\%$  &  $\Delta P_{d3}=3\%$  with parameter changes (GA).**



**Fig. 5(a). ACE Response.**



**Fig. 5(b). Frequency Response.**



**Fig. 5(c). Tie-Line Power Response.**

**Fig. 5. System Response for  $\Delta P_{d1}=\Delta P_{d2}=5\%$ ,  $\Delta P_{d3}=3\%$ , parameters variation & nonlinearity (GA).**

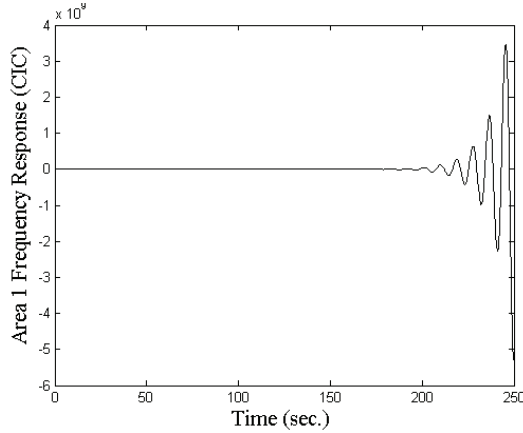


Fig. 6. System Response for  $\Delta P_{d1}=\Delta P_{d2}=5\%$ ,  $\Delta P_{d3}=3\%$ , parameters variation & nonlinearity (CIC).

## 8. Conclusion

This paper presented the design of a discrete-time optimal Output Feedback Control (OFC) for a decentralized Load Frequency Control (LFC) system to achieve improvements in transient and steady state responses, and to insure zero steady-state errors. The optimization technique used is the Genetic Algorithm (GA). The proposed approach has been applied to a three-area power system connected in a longitudinal structure where different disturbances were applied. The results of local decentralized discrete output feedback controllers were encouraging. To show the effectiveness of the proposed GA-based OFC, a comparative study with the Conventional Integral Control (CIC) is presented where GA shows superior performance improvement.

The advantages of the proposed controller over the widely known optimal state feedback controllers as applied to LFC design are as follows.

1. The system states should be measured or estimated in order to apply state feedback optimal control as it is not the case for OFC where only measured signals such as the Area Control Error (ACE) and its historical data are used.
2. The proposed controller is local; therefore, each area is regulated by using its own measurable data.
3. The realization of each regulator is simple and costless

As an extension to this work, power system connected in longitudinal or ring multi-area with and without nonlinearities will be considered.

### **Acknowledgement**

A special thanks is given to Dr. Abdel Ghany for his useful contributions to the completion of this work.

### **Notations**

$\mathbf{x}$	state vector
$\mathbf{u}$	control & disturbance vector
$F_i$	frequency deviations of area $i$
$P_{tiei}$	tie-line "i" power
$P_{di}$	load demand (disturbance) in area "i"
$P_{ci}$	speed changer position control in area "i"
$ACE_i$	Area control error in area "i"

### **References**

- [1]. **Elgerd, O.I.**, *Electric Energy System Theory: An Introduction*, McGraw-Hill, NY (1982).
- [2]. **Wood, A.J.** and **Wollenberg, B. F.**, *Power Generation operation and control*, John Wiley and Sons Inc., New York (1994).
- [3]. **Shayeghi, H.**, **Shayanfar, H.A.** and **Jalili, A.**, Load frequency control strategies: A state-of-the-art survey for the researcher, *Energy Conversion and Management*, **50**, 2, 344-353, (2009).
- [4]. **Abdel Ghany, A.M.**, Discrete Time Decentralized Load Frequency Controllers, *Proc. Regional Conference of CIGRE Committees in Arab Countries*, Doha, Qatar, 25-27 (1999).
- [5]. **Feliachi, A.**, Optimal Decentralized Load Frequency Control, *IEEE Transactions on Power Systems*, **2**(2): 379 – 385 (1987).
- [6]. **Rerkpreedapong, D.** and **Feliachi, A.**, Decentralized  $H_\infty$  load frequency control using LMI control toolbox, *Proc. of the Int. Symposium on Circuits and Systems, ISCAS '03*, **3**, III, 411-414 (2003).
- [7]. **Abdel Ghany, A.M.**, **Bahgat, M.E.** and **Abdalla, O.H.**, Decentralized Pole-Placement Load Controller for a Multi-Area Power System, *Proc. Regional Conference of CIGRE Committees in Arab Countries*, Cairo, Egypt, 27-30 (1997).
- [8]. **Feliachi, A.**, Optimal Decentralized Load Frequency Control, *IEEE Trans. on Power Systems*, **2**(2):379-386 (1987).
- [9]. **Demello, F.P.**, **Mills, R.J.** and **Brells, W.F.**, Automatic Generation Control, Part II-Digital Control Techniques, *IEEE Trans. on Power Apparatus and Systems*, **PAS-92**, 716-724 (1973).
- [10]. **Çam, E.** and **Kocaarslan, L.**, Load frequency control in two area power systems using fuzzy logic controller, *Energy Conversion and Management*, **46**(2): 233-240 (2005).



- [11]. **Bevrani, H., Mitani, Y. and Tsuji, K.**, Robust Decentralized Load Frequency Control Using an Iterative Linear Matrix Inequalities Algorithm, *Proc. IEE, Generation Transmission Distribution*, **151**(3): 347-54 (2004).
- [12]. **Bensenouci, A., and AbdelGhany, A.M.**, Mixed  $H_\infty/H_2$  with Pole-Placement Design of Robust LMI-Based Output Feedback Controllers for Multi-Area Load Frequency Control, *Proc. IEEE Int. Conf. on Computer as a Tool, EUROCON 2007*, Warsaw, Poland (2007).
- [13]. **Keisuke, Y., et al.**, Load Frequency Control using Demand Estimation and Genetic Algorithm, *IEE Japan Technical Meeting on Power Engineering*, **PE-00**, 108-123, 31-35, (2000).
- [14]. **Abdel-Magid, Y.L. and Dawoud, M.M.**, Genetic algorithms applications in load frequency control, *Proc. 1<sup>st</sup> International Conference on Genetic Algorithms in Engineering Systems: Innovations and Applications (GALESIA)*, Sheffield, UK, 207-213 (1995).
- [15]. **Rerkpreedapong, D., et al.**, Robust load frequency control using genetic algorithms and linear matrix inequalities, *IEEE Transactions on Power Systems*, **18**(2): 855 – 861 (2003).
- [16]. **Goldberg, D.E.**, *Genetic Algorithms in Search, Optimization, and Machine Learning*, Addison-Wesley, NY (1989).
- [17]. **Bensenouci, A. and AlGhamdi, S.A.**, Genetic Algorithm - Theory and Applications, *Proc. 1<sup>st</sup> Saudi Technical Conference & Exhibition, STCEX2000*, Riyadh (2000).
- [18]. **Aditya, S.K.**, Design of Load Frequency Controllers Using Genetic Algorithm for Two Area Interconnected Hydro Power System, *Electric Power Components and Systems*, **31** (1): 81-94 (2003).
- [19]. **Silijak, D.D.**, *Decentralized Control of Complex Systems*, Academic Press, Boston (1991).
- [20]. **Silijak, D.D.**, Complex Dynamic systems: Stability, Control and Reliability, *Proc. Arab School on Science and Technology: Control System Theory and Applications*, Bloudan, Syria (1981).
- [21]. **Hiyama, T.**, Optimization of Discrete-Type Load-Frequency Regulators Considering Generation-Rate Constraints, *Proc. IEE*, **129**(C,6) 285-289 (1982).
- [22]. **Tripathy, S.C., et al.**, Optimization of Load Frequency Control Parameters with Reheat Steam Turbines and Governor Deadband Non-linearity, *Proc. IEE*, **129**(C, 1): 10-12 (1982).
- [23]. **IEEE Committee Report**, *Dynamic Models for Steam and Hydro Turbines in Power System Studies*, IEEE Press on Stability of Large Electric Power Systems, 138 (1973).
- [24]. **Walker, P.A.W. and Abdallah, O.H.**, Discrete Control of an A.C. Turbogenerator by Output Feedback, *Proc. of the IEE, Control & Science*, **125**(9): 1031-38 (1978).
- [25]. **Abdallah, O.H. and Osheba, S.M.**, Computer Control of a Turbogenerator System with a Single Output-Feedback Strategy, *Engineering Results Bulletin*, Faculty of Eng. and Tech., Monofia Univ., **2**: 147-168 (1983).
- [26]. **Bensenouci, A., et al.**, Simulated Annealing and Dynamic Programming Based Optimum Discrete-Time Output Feedback for a Three-Area Decentralized Load Frequency Control, *Proc. 6<sup>th</sup> CIGRE, Cairo, Egypt* (2005).
- [27]. **Bensenouci, A. and Abdel Ghany, A.M.**, Optimal Discrete-Time Output Feedback Control for Multi-Area Load Frequency Control Using Evolutionary Programming, *Proc. IEEE Int. Symposium on Industrial Electronics, ISIE2005*, Dubrovnik, Croatia (2005).

## Appendices

### Appendix A1: System Data

The parameters of the first area:

$$Tp_1=3.76; kp_1=20; T_w=1; T_3=32; T_2=5; T_1=0.6; R_1=3; T_{12}=0.545/(2*\pi); B_1=0.383;$$

The parameters of the second area:

$$kp_2=80; Tp_2=20; Tt_1=0.3; Tr_1=10; k_{r1}=0.5; Tg_1=0.38; R_2=2.4; T_{21}=T_{12}; B_2=0.425;$$

The parameters of the third area:

$$kp_3=100; Tp_3=20; T_{32}=T_{21}; Tg_2=0.4; R_3=2.4; B_3=0.425$$

### Appendix A2: Genetic Algorithm

#### Step 1: Initialization

Select appropriate search intervals for

$$\mathbf{F}=\{F_1, \dots, F_{N_{pop}}\}$$

Where

$N_{pop}$  is the population size, and

$F_i$  is the  $i^{\text{th}}$  chromosome written as a horizontal concatenation:  $F_i = [F_1 F_2 \dots F_m]$   
where  $i=1, \dots, N_{pop}$

$m$ : being the number of parameters to be optimized.

The parameter  $F_j=p_j$  is bounded, i.e.,  $p_j \in [p_{\min,j}, p_{\max,j}]$  where  $j = 1, \dots, m$ .

The optimum of the fitness function  $f(\mathbf{F})$  is evaluated for each chromosome  $F_i$  written in real-based numbers whereas, the three main GA steps use binary-based numbers. The passage from real to binary (encoding) and vice versa (decoding) is illustrated through an example shortly.

Generate randomly a population  $P_{k=0}$ . The index “k” is a counter that represents the generation index ( $k=0$ , initial population,  $k=1$ , 1<sup>st</sup> generation, etc.).

*Encoding/Decoding of a Chromosome:*

Because floating binary numbers are used in GA, a conversion from real to binary (encoding) and vice versa (decoding) is required.

*Encoding of String 2 of  $F_{i1}$ :*

$$F_{i1bin} = dec2bin[(F_{i1dec} - p_{1min})/Q_1], Q_1=(p_{1max} - p_{1min})/(2^{N_{bit}} - 1)$$

*Decoding of String 2 of  $F_{i1}$ :*

$$F_{i1dec} = bin2dec[F_{i1bin}] * Q_1 + p_{1min}, Q_1=(F_{i1max} - F_{i1min})/(2^{N_{bit}} - 1)$$

With

*bin2dec*: conversion from binary to decimal

*dec2bin*: conversion from decimal to binary

#### Step 2: Reproduction

- For each value of  $\mathbf{F} = \{F_1, \dots, F_{N_{pop}}\}$ , evaluate the value of the corresponding fitness function, i.e.  $f(F_1), \dots, f(F_{N_{pop}})$ .
- Compute the total value of the fitness function  $F_{tot} = f(F_1) + \dots + f(F_{N_{pop}})$ .
- Compute the probability of selection for each chromosome  $F_i$ :  $p_i = f(F_i)/F_{tot}$ ,  $i=1, \dots, N_{pop}$ .

- Compute the cumulative probability for each chromosome  $F_i$ :  $q_i = p_1 + \dots + p_i$
- Generate a random number  $r \in [0, 1]$ .
- For all  $F_i$  ( $i=1, \dots, N_{pop}$ ) do the following: if  $r < q_1$  select  $F_1$  as a candidate for reproduction, otherwise select  $F_t$  such that  $q_{t-1} < r < q_t$ .
- At this stage, some chromosomes will survive (reproduced or kept) whereas others will die (eliminated).

### Step 3: Crossover

- The probability of crossover,  $P_c$ , gives the number of chromosomes  $r_c$  that will undergo the crossover process:  $r_c = P_c * N_{pop}$ , i.e.  $P_c$  times the size of the population.
- For each chromosome of the generation (after reproduction), generate a random number  $r \in [0, 1]$  interval, then choose  $F_i$  ( $i=1, \dots, N_{pop}$ ) for which  $r < P_c$ .
- Randomly couple the chromosomes, that is, each 2 chromosomes together.
- For each couple, randomly generate an integer number "pos" in  $[1, N_{pop}]$  interval. This number indicates the position of the bit submitted to crossover position, i.e., for  $r_c=1$ :

$$F_1 = (b_1 \dots b_{pos} b_{pos+1} \dots b_{N_b}), F_2 = (c_1 \dots c_{pos} c_{pos+1} \dots c_{N_b})$$

are replaced by

$$F_1 = (b_1 \dots b_{pos} c_{pos+1} b_{pos+2} \dots b_{N_b}), F_2 = (c_1 \dots c_{pos} b_{pos+1} c_{pos+2} \dots c_{N_b})$$

Where  $N_b$  is the number of bits.

### Step 4: Mutation

The probability of mutation,  $P_M$ , gives the number  $r_M$  of bits in a chromosome to undergo the mutation process:  $r_M = N_b * P_M * N_{pop}$ . For each bit, generate a random number  $r \in [0, 1]$  then inverse the bit if  $r < P_M$ .

### Step 5: Updating and Stopping Criterion

At this point, a new generation  $P_{k+1}$  is obtained from  $P_k$ . Set  $P_k = P_{k+1}$  and repeat step 2 (reproduction), step 3 (crossover) and step 4 (mutation) using the new  $P_i$  until convergence is obtained, i.e., error =  $|P_k - P_{k-1}| < \varepsilon$  where  $\varepsilon$  is a predetermined tolerance.

## Appendix A3: Output Feedback Control

On the basis of an assumed sampling interval  $T_s$ , the state prediction equation of the discrete-time linear model described by

$$\begin{cases} \mathbf{x}_{k+1} = \Phi \mathbf{x}_k + \Delta \mathbf{u}_k \\ \mathbf{y}_k = \mathbf{C} \mathbf{x}_k \end{cases} \quad (\text{A3.1})$$

Using (A3.1), the following equation can be derived:

$$\mathbf{z}_k = \mathbf{H}_1 \mathbf{x}_{k+1} - \mathbf{H}_2 \mathbf{v}_k \quad (\text{A3.2})$$

Where

$$\mathbf{H}_1 = \begin{bmatrix} \mathbf{C}\Phi^{-1}\Delta \\ \mathbf{C}\Phi^{-2}\Delta \\ \dots \\ \mathbf{C}\Phi^{-N}\Delta \end{bmatrix} \quad \mathbf{H}_2 = \begin{bmatrix} \mathbf{C}\Phi^{-1}\Delta & \mathbf{0} & \dots & \mathbf{0} \\ \mathbf{C}\Phi^{-2}\Delta & \mathbf{C}\Phi^{-1}\Delta & \dots & \mathbf{0} \\ \dots & \dots & \dots & \mathbf{0} \\ \mathbf{C}\Phi^{-N}\Delta & \mathbf{C}\Phi^{-N+1}\Delta & \dots & \mathbf{C}\Phi^{-1}\Delta \end{bmatrix} \quad (\text{A3.3})$$

With  $\mathbf{H}_1$  ( $N \times N$ ),  $\mathbf{H}_2$  ( $N \times N$ ), and  $N$  is the number of measurements of the outputs and inputs from  $t=kT_s$  back to  $t=(k-N+1)T_s$ .

Multiplying (A3.3) by  $\mathbf{H}_1^{-1}$ , one gets

$$\mathbf{x}_{k+1} = \mathbf{F}_1 \mathbf{z}_k + \mathbf{F}_2 \mathbf{v}_k \quad (\text{A3.4})$$

Where;

$$\mathbf{z}_k = [\mathbf{y}_k \quad \mathbf{y}_{k-1} \quad \dots \quad \mathbf{y}_{k-N+1}]^t \quad \mathbf{v}_k = [\mathbf{u}_k \quad \mathbf{u}_{k-1} \quad \dots \quad \mathbf{u}_{k-N+1}]^t$$

$$\mathbf{F}_1 = \mathbf{H}_1^{-1} \quad \mathbf{F}_2 = \mathbf{H}_1^{-1} \mathbf{H}_2$$

The output-prediction equation can obtain as follows:

$$\mathbf{y}_{k+1} = \mathbf{C} \mathbf{x}_{k+1} = \boldsymbol{\alpha} \mathbf{z}_k + \boldsymbol{\beta} \mathbf{v}_k \quad (\text{A3.5})$$

$$\boldsymbol{\alpha} = \mathbf{C} \mathbf{F}_1 \quad \boldsymbol{\beta} = \mathbf{C} \mathbf{F}_2$$

Equation (A3.5) completely defines the process dynamics without reference to the state vector  $\mathbf{x}$ . The minimum number of previous  $N$  measurements is selected such that  $N \geq n/p$  where  $p$  is the number of outputs and  $n$  the dimension of  $\Phi$  [14-15].

To obtain output predication formulation, (A3.5) can be rearranged as follows. After vertically partitioning  $\boldsymbol{\beta}$  into  $\boldsymbol{\beta}_2$  and  $\boldsymbol{\beta}_1$ , (A3.5) becomes:

$$\mathbf{y}_{k+1} = \boldsymbol{\alpha} \mathbf{z}_k + [\boldsymbol{\beta}_2; \boldsymbol{\beta}_1] \mathbf{v}_k \quad (\text{A3.6})$$

$$\mathbf{y}_{k+1} = [\boldsymbol{\alpha}; \boldsymbol{\beta}_1] [\mathbf{z}_k \quad \dots \quad \mathbf{u}_{k-1} \quad \dots \quad \mathbf{u}_{k-N+1}]^t + \boldsymbol{\beta}_2 \mathbf{u}_k \quad (\text{A3.7})$$

And (A3.7) is augmented by additional rows to form;

$$\begin{bmatrix} \mathbf{Y}_{k+1} \\ \dots \\ \mathbf{Y}_k \\ \vdots \\ \mathbf{Y}_{k-N+2} \\ \dots \\ \mathbf{u}_k \\ \mathbf{u}_{k-1} \\ \vdots \\ \mathbf{u}_{k-N+1} \end{bmatrix} = \begin{bmatrix} \alpha_{11} \dots \alpha_{1N} & \vdots & \beta_{11} \dots & \beta_{1N} \\ \dots & \vdots & \dots & \dots \\ \mathbf{I}_p & \mathbf{0} \dots \mathbf{0} & \vdots & \mathbf{0} \dots \mathbf{0} \\ \vdots & \vdots & \vdots & \vdots \\ \mathbf{0} & \mathbf{0} \dots \mathbf{I}_p & \mathbf{0} & \mathbf{0} \dots \mathbf{0} \\ \dots & \dots & \dots & \dots \\ \mathbf{0} & \mathbf{0} \dots \mathbf{0} & \vdots & \mathbf{0} \dots \mathbf{0} \\ \mathbf{0} & \mathbf{0} \dots \mathbf{0} & \vdots & \mathbf{I}_M \\ \vdots & \vdots & \vdots & \vdots \\ \mathbf{0} & \mathbf{0} \dots \mathbf{0} & \vdots & \mathbf{0} \dots \mathbf{I}_M \end{bmatrix} \begin{bmatrix} \mathbf{Y}_k \\ \mathbf{Y}_{k-1} \\ \vdots \\ \mathbf{Y}_{k-N+1} \\ \dots \\ \mathbf{u}_{k-1} \\ \mathbf{u}_{k-2} \\ \vdots \\ \mathbf{u}_{k-N+1} \end{bmatrix} + \begin{bmatrix} \boldsymbol{\beta}_2 \\ \dots \\ \mathbf{0} \\ \vdots \\ \mathbf{0} \\ \dots \\ \mathbf{I}_M \\ \mathbf{0} \\ \vdots \\ \mathbf{0} \end{bmatrix} \mathbf{u}_k \quad (\text{A3.8})$$

Or, in simplified form,

$$\mathbf{w}_{k+1} = \begin{bmatrix} \mathbf{z}_{k+1} \\ \mathbf{v}_k \end{bmatrix} = \boldsymbol{\theta} \begin{bmatrix} \mathbf{z}_k \\ \mathbf{v}_{k-1} \end{bmatrix} + \boldsymbol{\Omega} \mathbf{u}_k$$

Thus, the prediction equation of the augmented vector  $\mathbf{w}_{k+1}$  can be written in compact form as:

$$\mathbf{w}_{k+1} = \boldsymbol{\theta} \mathbf{w}_k + \boldsymbol{\Omega} \mathbf{u}_k \quad (\text{A3.9})$$

A state feedback optimal control law for the system described by (A3.1),  $u_k = F_s x_k$ , may be found by minimizing, with respect to  $u_k$ , the quadratic-performance index:

$$J_s = \sum_{k=0}^r \left[ x_{k+1}^t Q_s x_{k+1} + u_{k+1}^t H_s u_{k+1} \right] \quad (A3.10)$$

Where  $F_s$  is the optimal state feedback gains.

Since (A3.9) is similar to (A3.1), by a similar way, an output feedback optimal control law for the system described by (A3.9),  $u_o = F_o w_o$ , may be found by minimizing, with respect to  $u_o$ , the quadratic-performance index:

When using (A3.9), one gets

$$J_o = \sum_{k=0}^r \left[ w_k^t Q w_k + u_k^t R u_k + u_k^t S u_k \right] \quad (A3.12)$$

Where

$$Q = F_5^t Q_s F_5 \quad R = 2F_4^t Q_s F_5 \quad S = F_4^t Q_s F_4 + H_s \quad (A3.13)$$

The matrix  $F_o$  is the optimal output feedback gains matrix. To obtain  $Q$ ,  $R$  and  $S$  matrices,  $F_4$  and  $F_5$  must be known. The matrices  $Q_s$  and  $H_s$  are weighting matrices that should be selected properly to meet some desired performance. The former should be symmetric positive semi-definite whereas, the later should be symmetric positive definite matrix to get the global minimum [14-15].  $F_4$  and  $F_5$  can be obtained as described next.

From (A3.4) and if  $F_2$  (NxN) is vertically partitioned into  $F_4$  (Nxm) and  $F_3$  (Nx[N-m]), (A3.4) becomes

$$x_{k+1} = F_1 z_k + [F_4; F_3] v_k \quad (A3.14)$$

That can be rearranged as:

$$x_{k+1} = [F_1; F_3] z_k + F_4 u_k = F_5 z_k + F_4 u_k \quad (A3.15)$$

To calculate the output feedback control gains  $F_o$ , two optimization solver techniques are used in this research work, namely, the Genetic Algorithm (GA) and the Dynamic Programming (DP).

## التصميم الأمثل لمتحكم ذي إشارة خرج راجعة باستخدام خوارزم الجيني لنظام القدرة المتعدد المناطق

أحمد بن سنوسي

قسم الهندسة الكهربائية - كلية الهندسية - جامعة القصيم، المملكة العربية  
السعودية

المستخلص. في هذه الورقة نقدم التصميم الأمثل لمتحكم ذو إشارة خرج راجعة لنظام قدرة مرتبط غير مركزي متعدد المناطق باستخدام الخوارزم الجيني (الوراثي). النظام الأصلي يجرى إلى عدة أنظمة أو مناطق. يتم تصميم نظام محلي لكل منطقة حيث إن مصفوفة الكسب مشتقة من استخدام الخوارزم الجيني (الوراثي). الطريقة المقترحة تم تطبيقها على نظام قدرة مكون من ثلاثة مناطق مرتبطة حيث يمكن توسيعه إلى عدد أكبر من المناطق المرتبطة بشكل حلقي أو طولي. يتم تحليل أداء النظام بتمثيل مختلف الاضطرابات. فاعلية النظام مبينة عن طريق دراسة مقارنة مع المتحكم التكاملي التناسبي التقليدي من خلال التشغيل على مدى نطاق واسع وبتغيير البرامترات.